

SCROLLSAW WORKSHOP

WWW.SCROLLSAWWORKSHOP.BLOGSPOT.COM

Digital Patterns

Designed by Steve Good



Hundreds of free Patterns
Stencil Printer
Jigsaw Puzzle Templates
DVD's
Key Chain Pattern Printer
Video Tutorials
Reviews
Community Forum and more.



Click to Donate.



Note to commercial print employees: I give my permission to print as many of this pattern book as your customer requires.

steve@stevedgood.com

Copyright Steve Good 2024

General Pattern Information



You may use this pattern to make as many of the project as you like. You are free to use any technique including mass production to build the project. The pattern may be copied and given to others provided the entire book is kept intact. You may not sell the pattern or include it in another commercial package of any type.

Steve Good retains the right to the pattern. If you have any questions about the use of this pattern please contact me at steve@stevedgood.com

When printing this pattern it is important to print it full size. When you bring up the print dialog box look in the "Page Sizing & Handling" section. Make sure the "Actual Size" is selected before you hit print.

You also only need to print the page/s you need. After the print dialog opens look for the "Pages to Print" section. You can print the current page or a range of pages. This will help save ink by not printing the title/instruction pages.

Printing Instructions



Page Sizing & Handling

Size

Poster

Multiple

Booklet

Fit

Actual size

Shrink oversized pages

Custom Scale: %

Choose paper source by PDF page size

Pages to Print

All

Current page

Pages

▶ More Options

Farm Set Toy





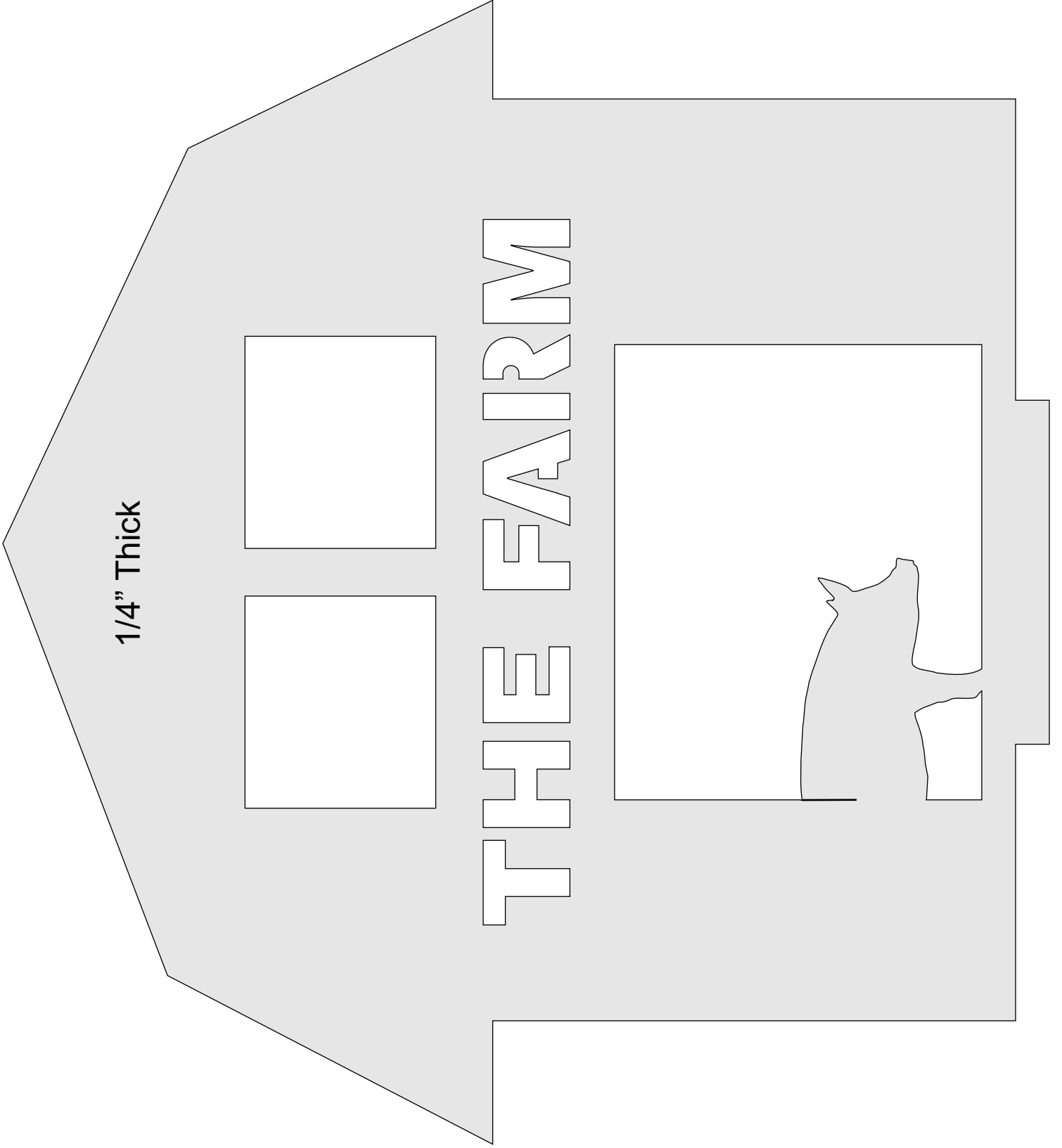

1/4" Thick

THE FAIRM

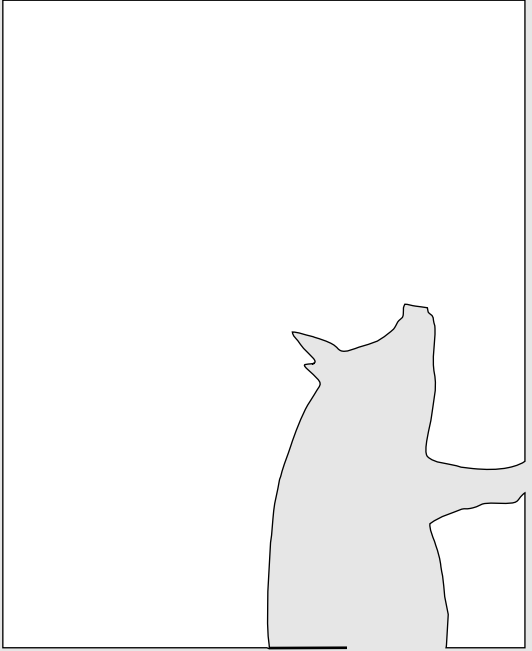
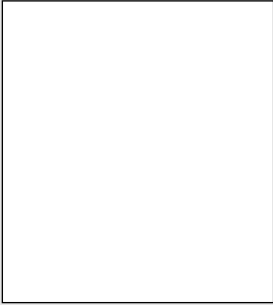
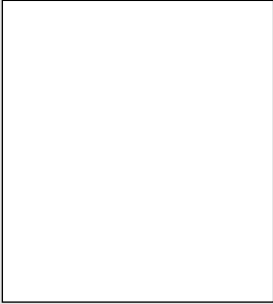

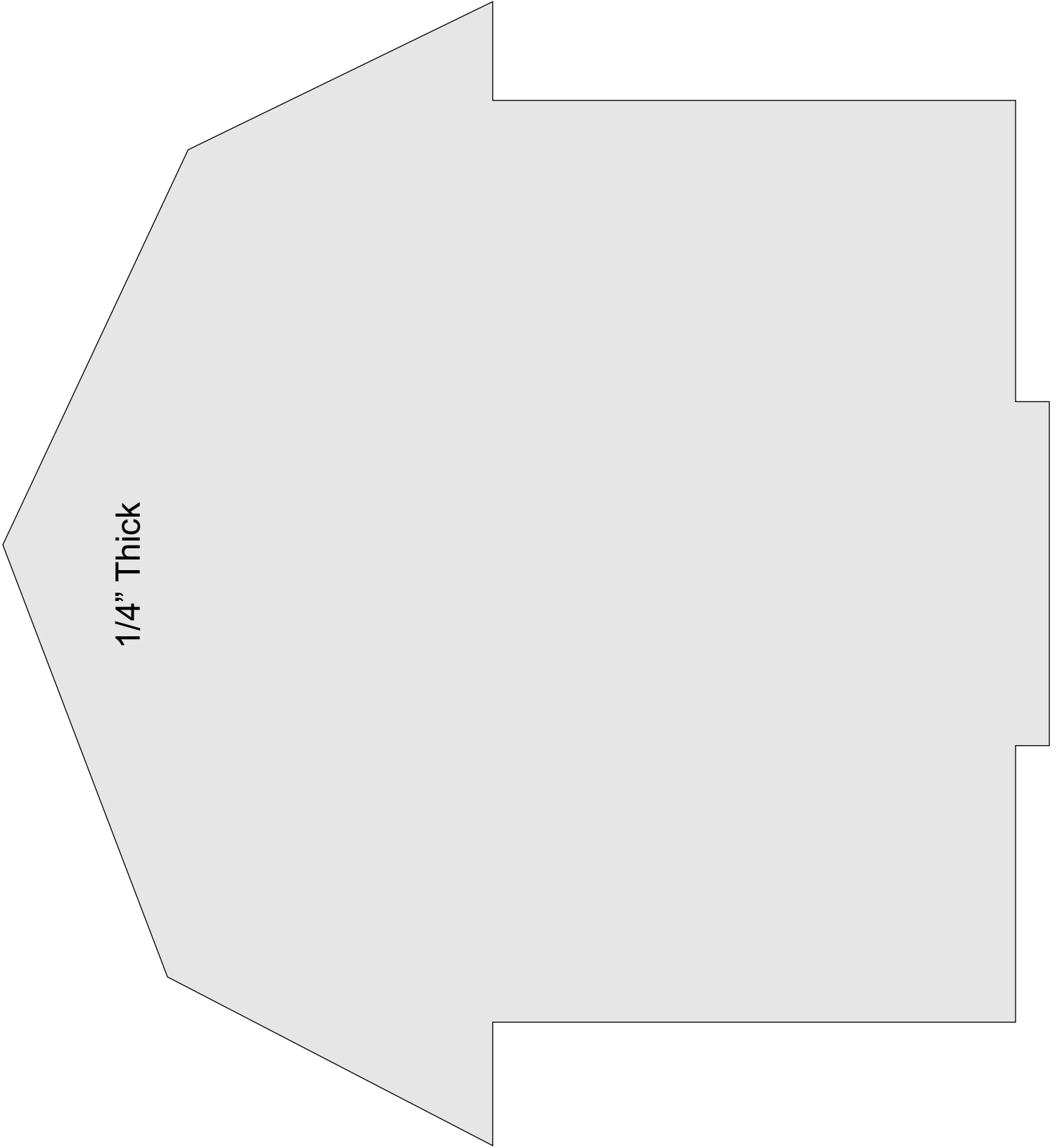

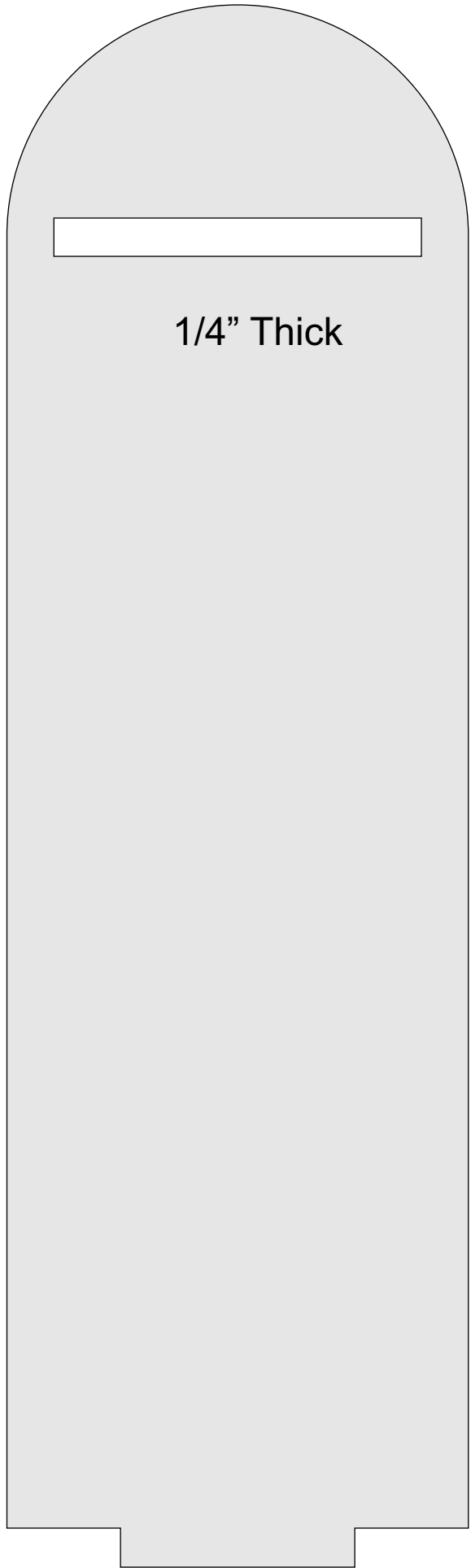
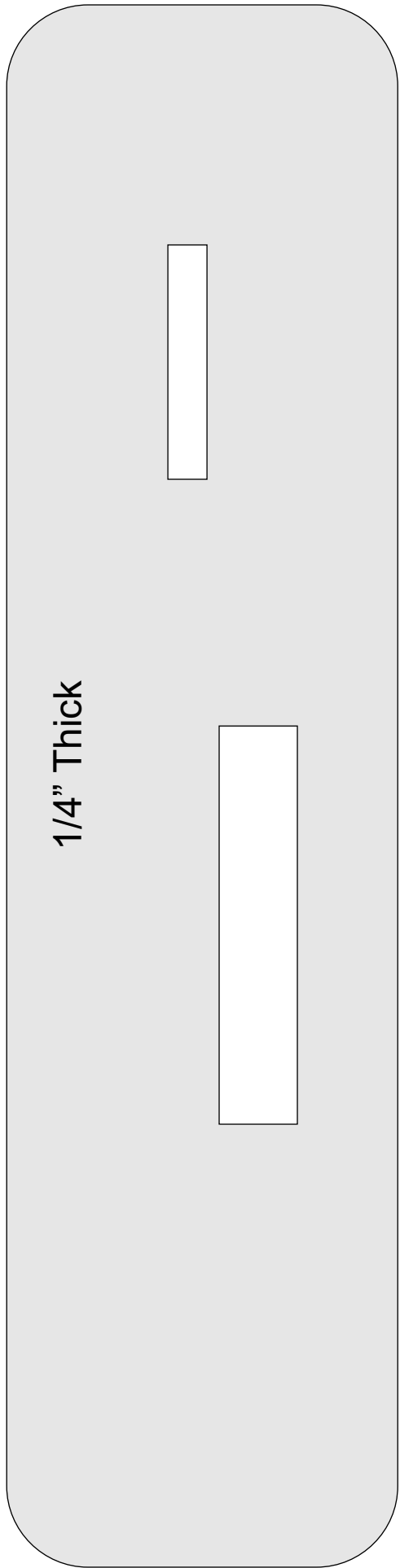

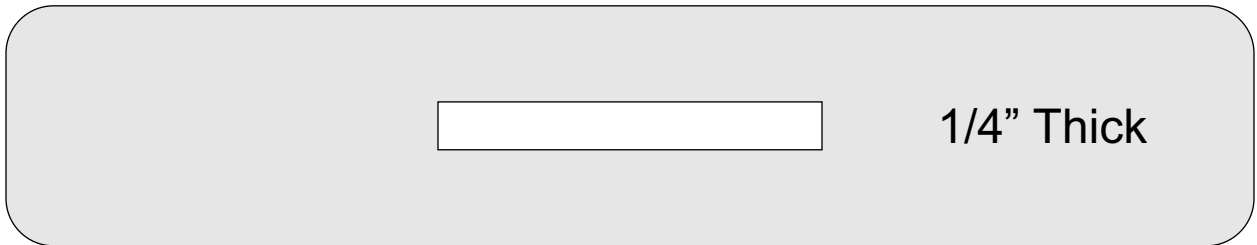
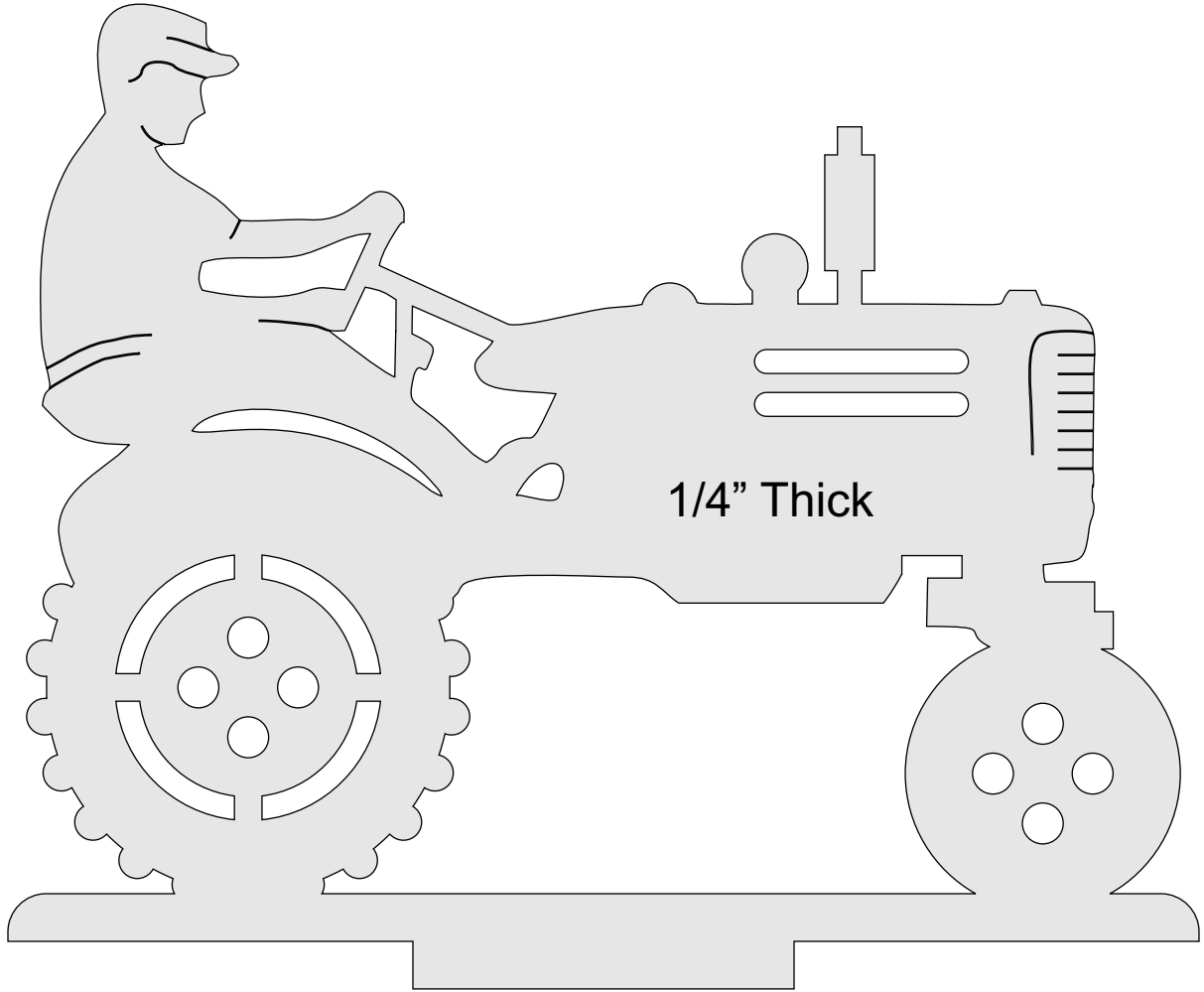

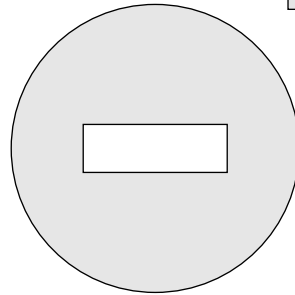
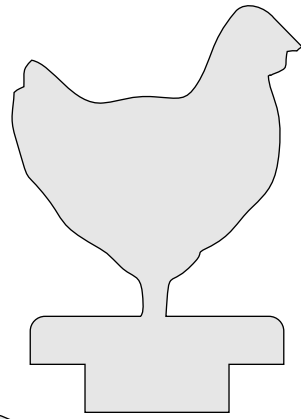
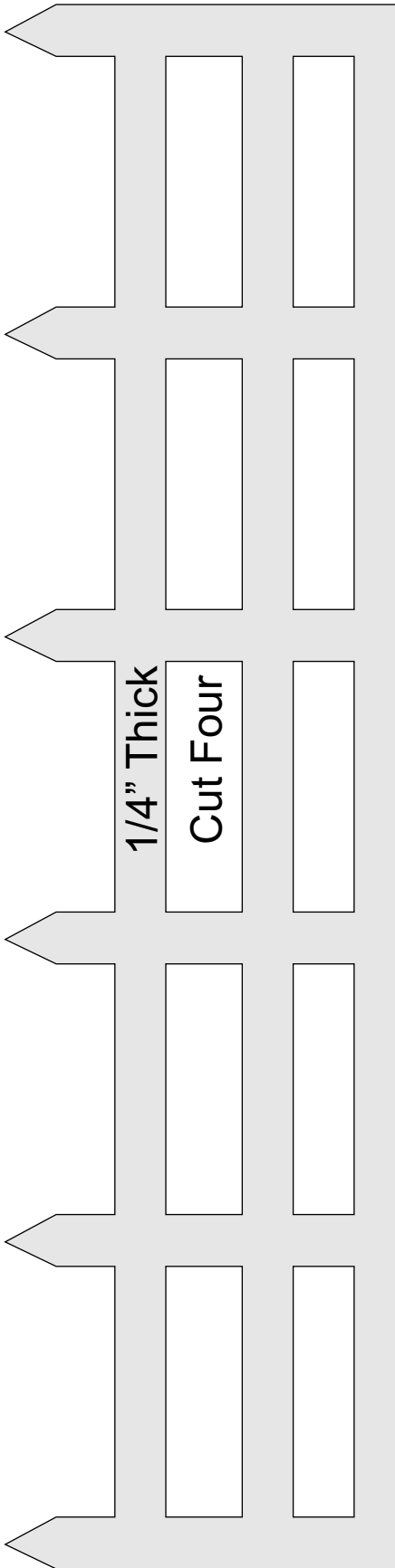

1/4" Thick

Cut multiples of each animal.

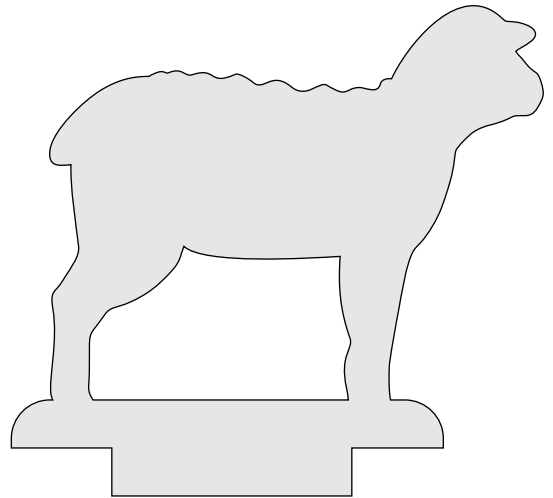

1/4" Thick

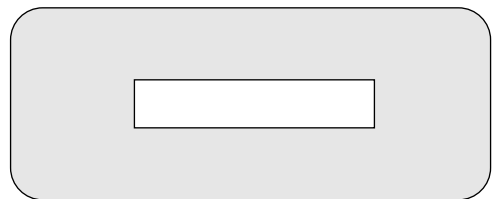

Cut multiples of each animal.

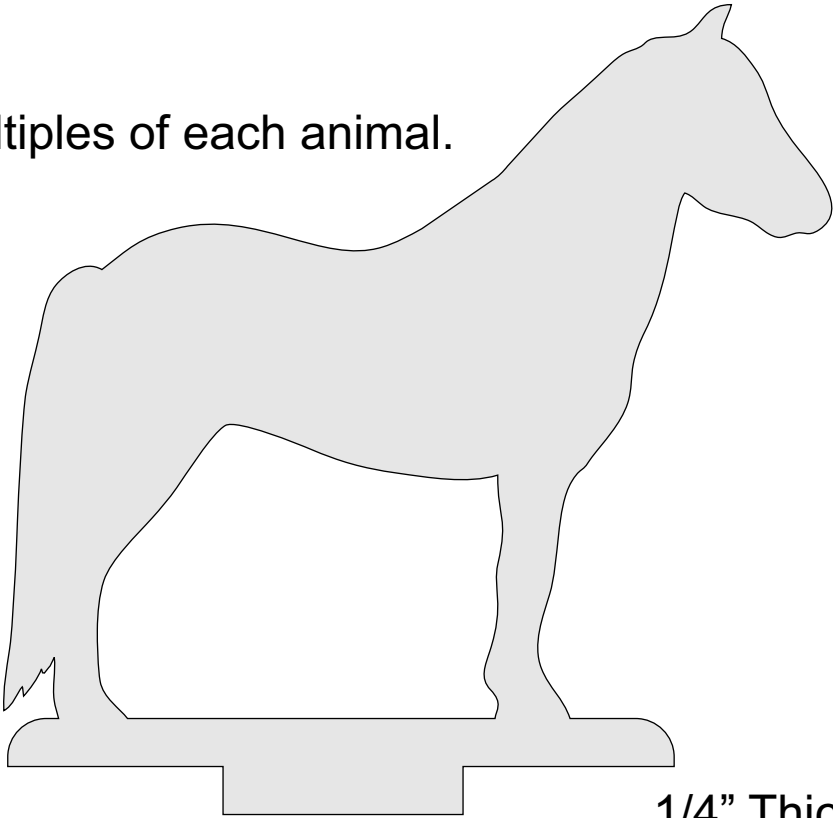

1/4" Thick

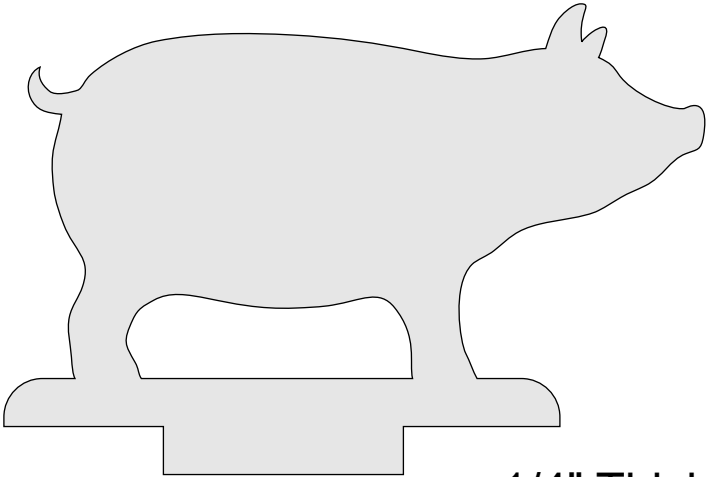
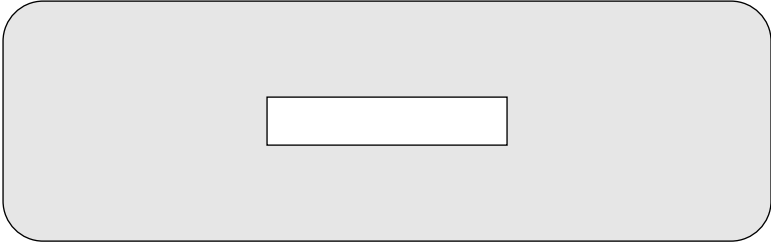

1/4" Thick

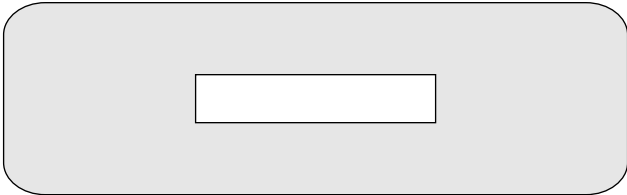

Cut multiples of each animal.

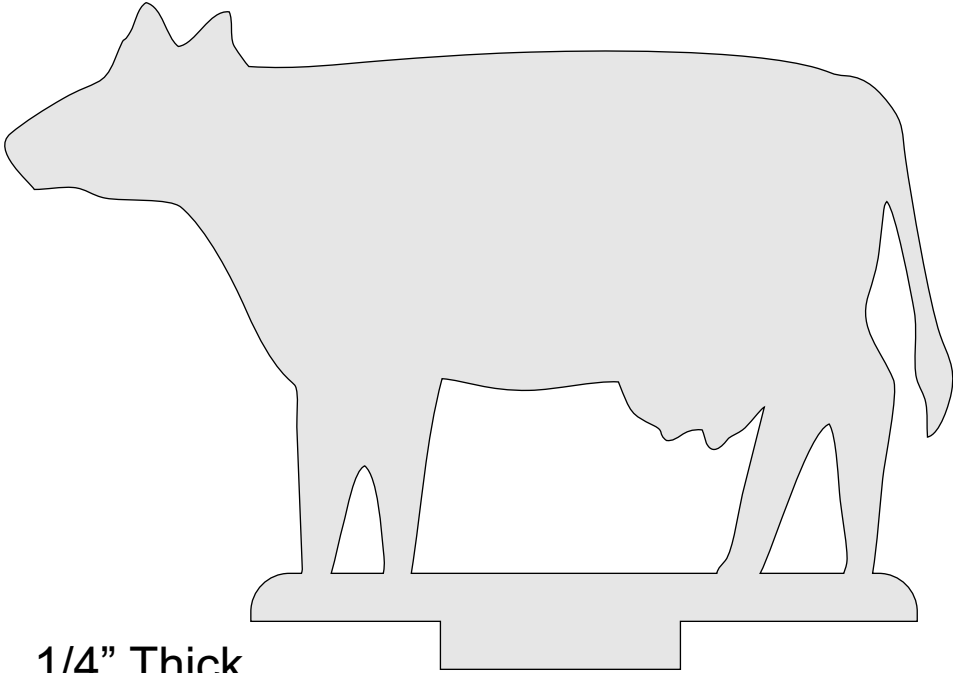

1/4" Thick

