

Digital Patterns



Designed by Steve Good

www.scrollsawworkshop.blogspot.com

Home of Scroll Saw Pattern Printer
and the Scroll Saw Key Chain Printer



Note to commercial print employees: I give my permission to print as many of this pattern book as your customer requires.

Cottage Bird House

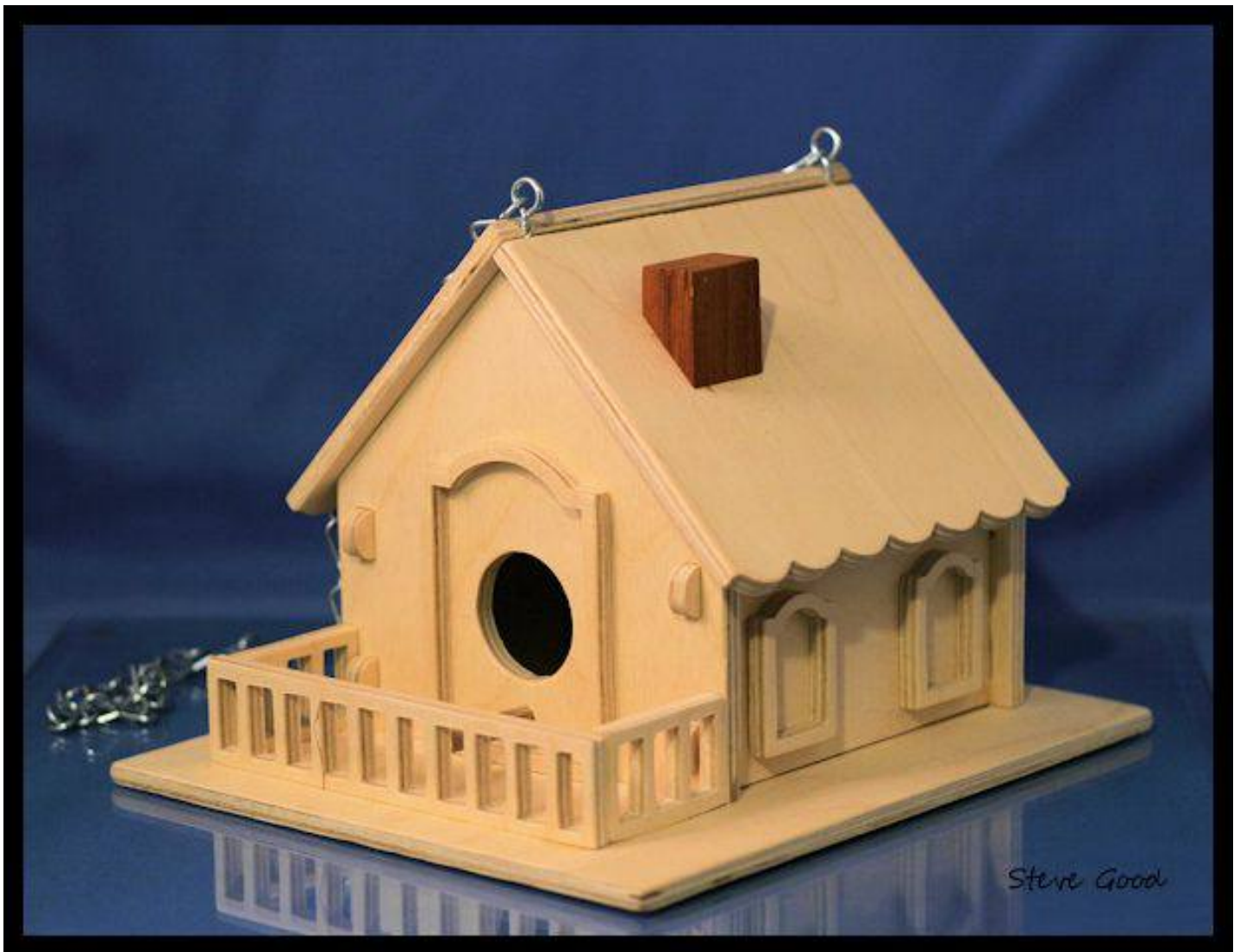

Made mostly from 1/4" Baltic Birch Ply.

Screw the base to the house for easy cleaning.



Glue the cleats into the bottom of the completed bird house. Pre-drill and counter sink the holes in the base and cleats.

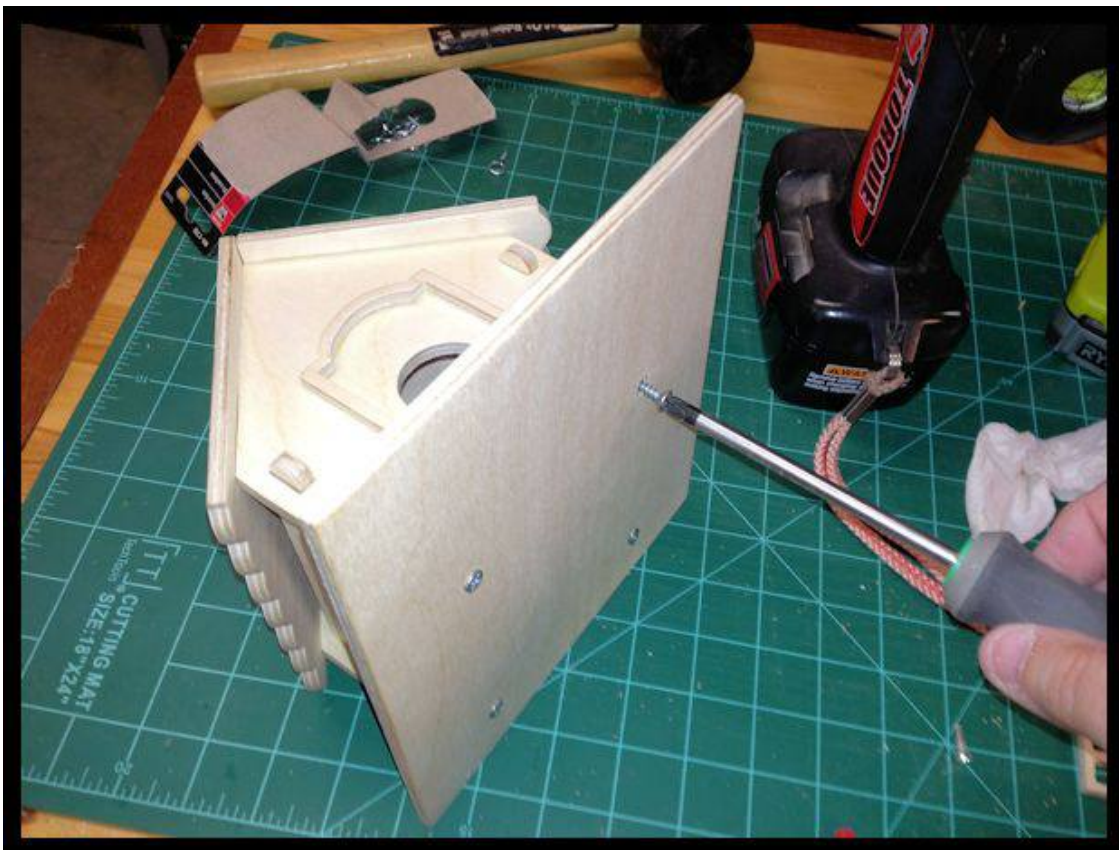

One method to hang the bird house.
Install eye screw at the peak of the
roof and use chain to hang from a limb.



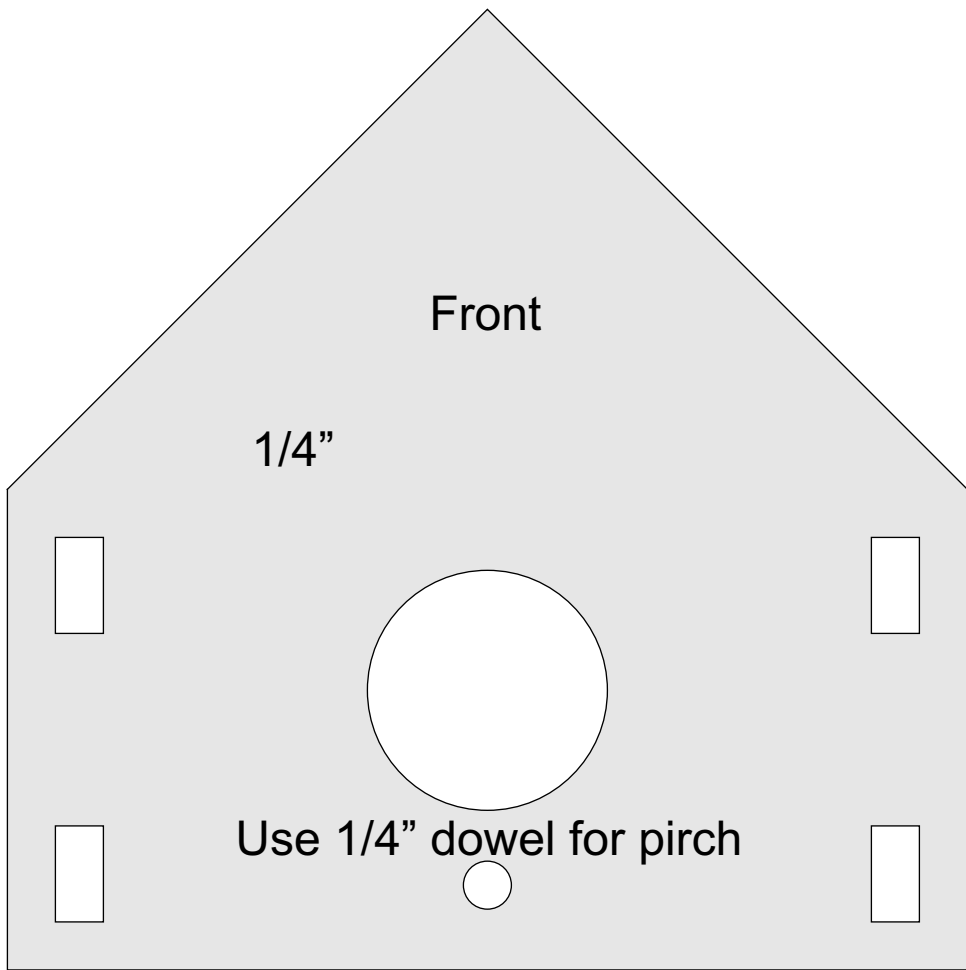

Chimney

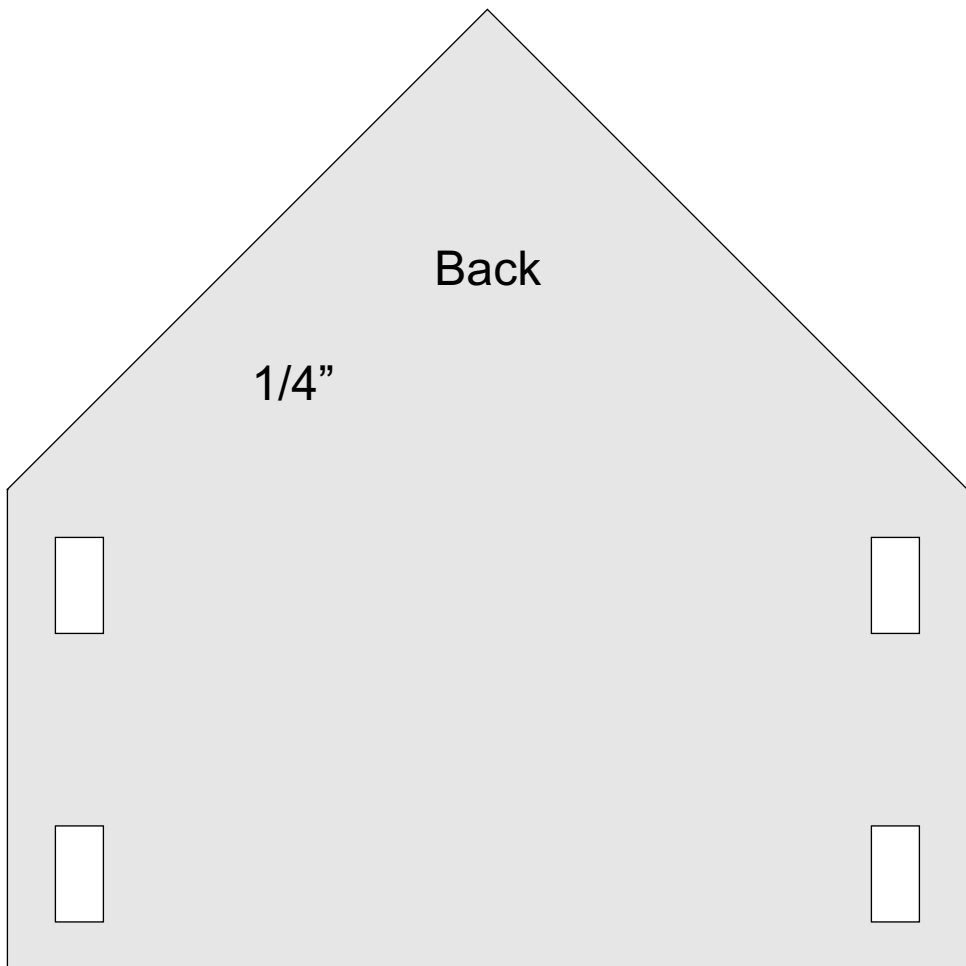
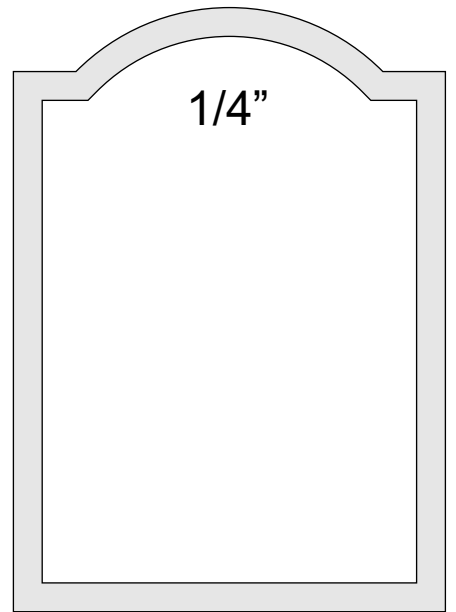

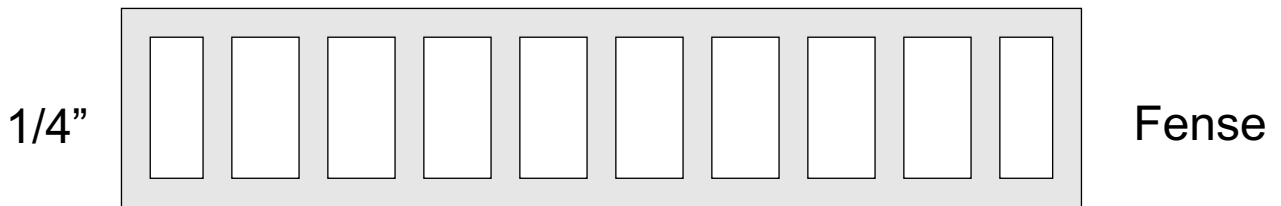
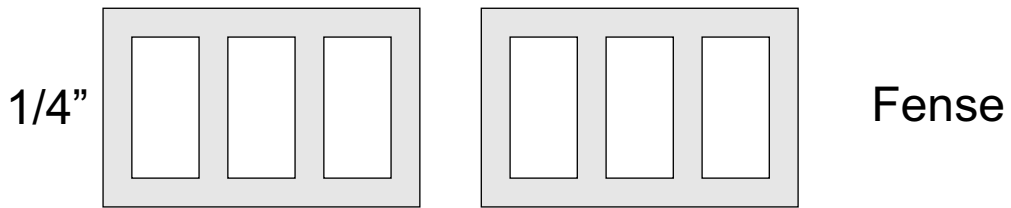
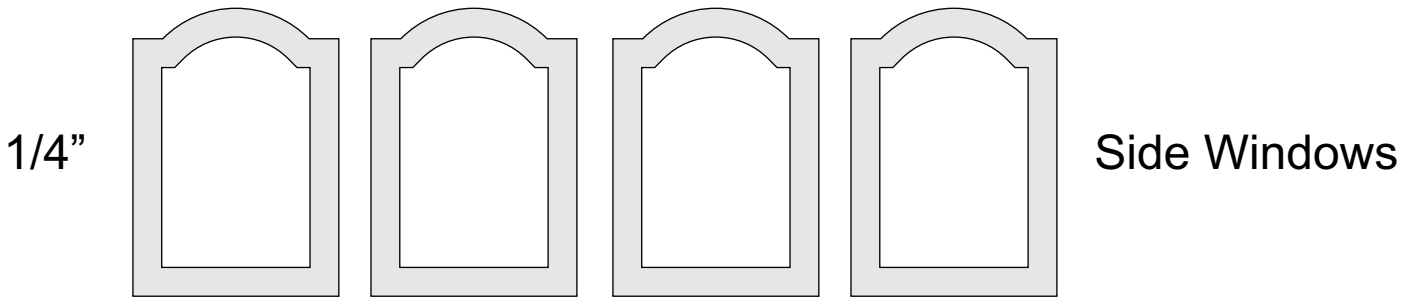

Roof

